

# OBDELAVA UMETNIH SNOVI

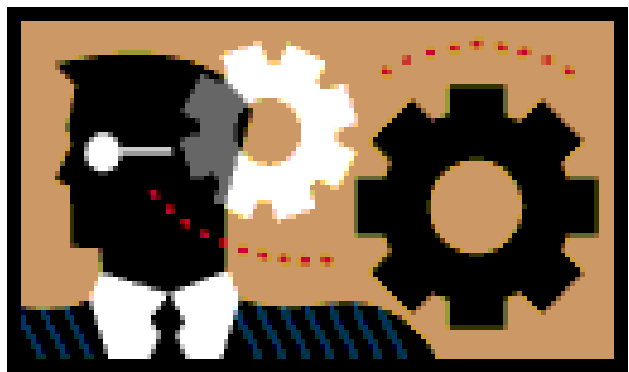

TEHNIKA IN TEHNOLOGIJA

- Odrezujemo

- Preoblikujemo

- Oblikujemo

- Spajamo

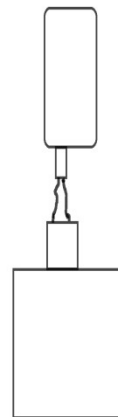

- Žaganje

- Vrtanje

- Brušenje

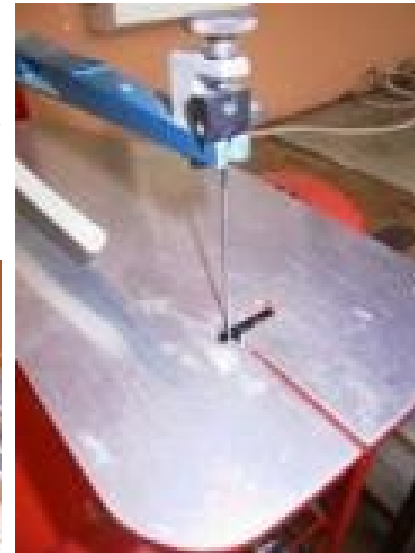

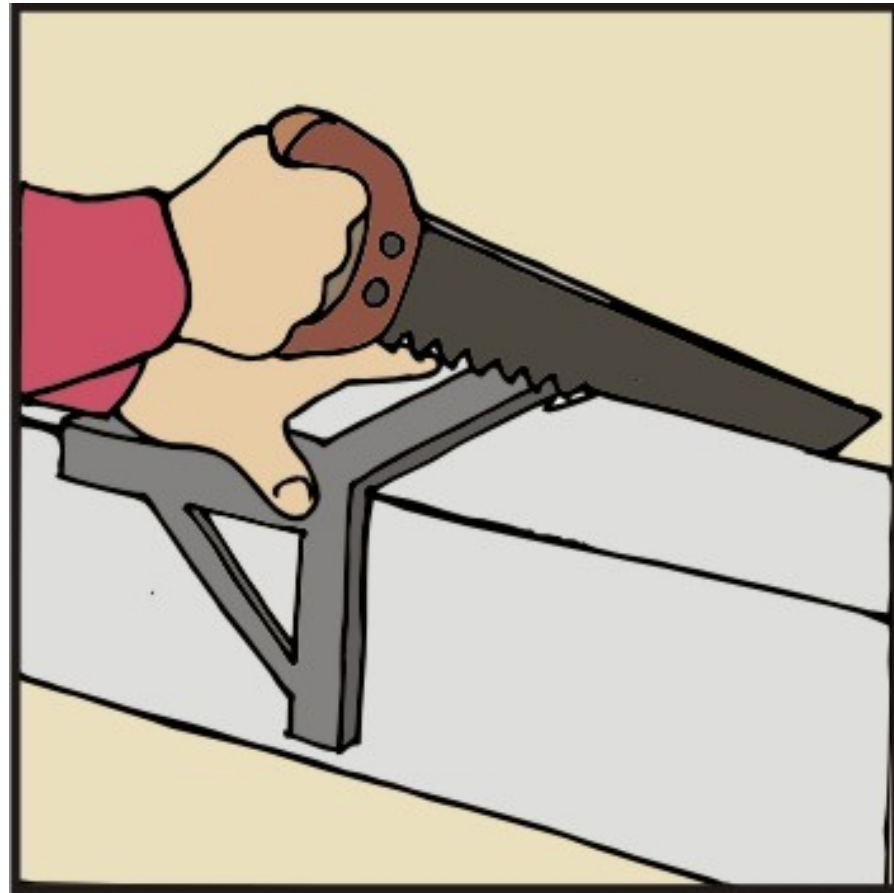

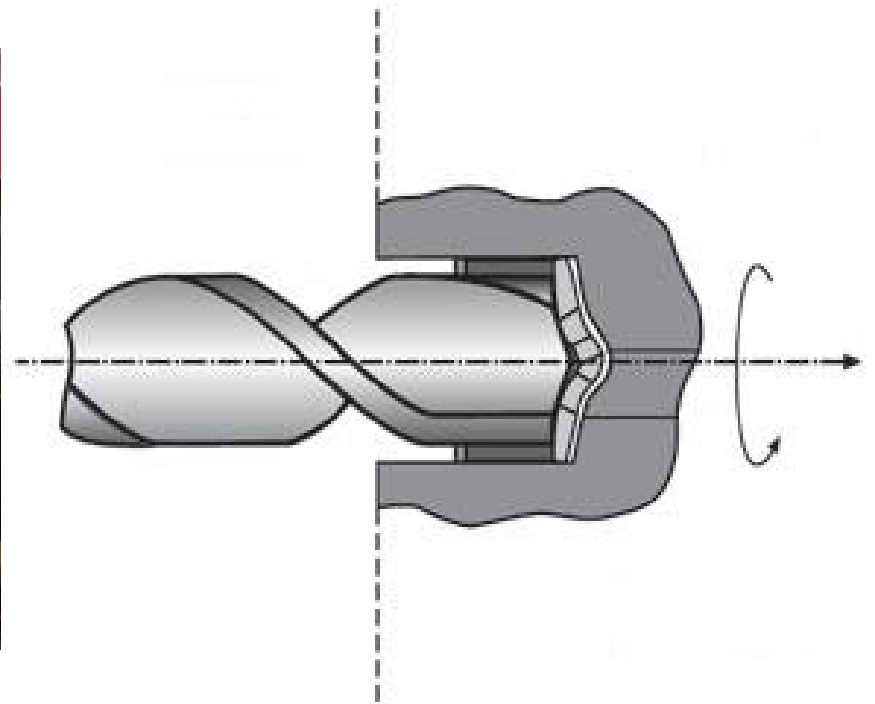



- Upogibamo →
- Vlečemo oz. globoki vle

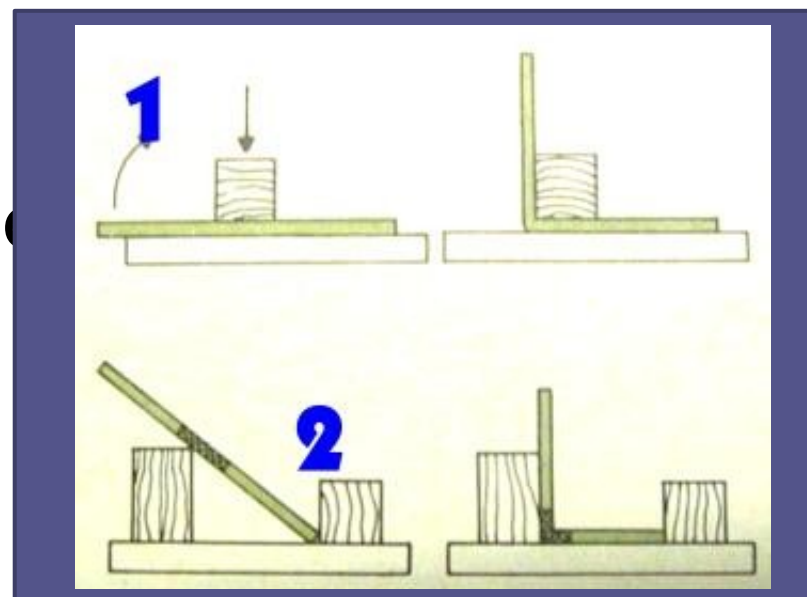
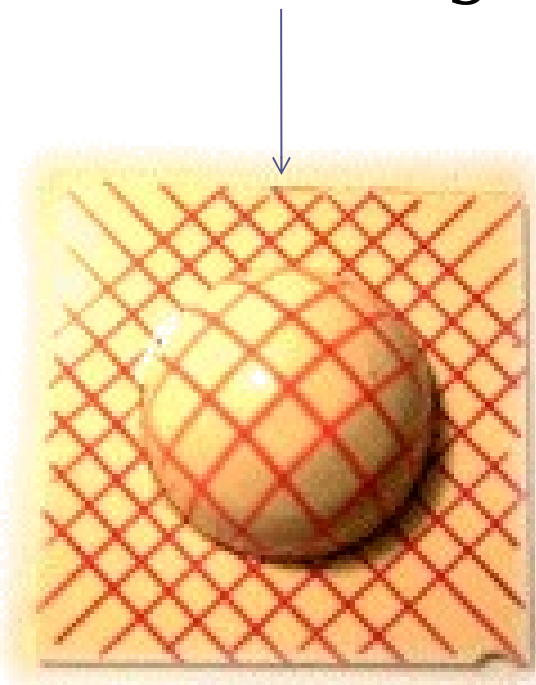





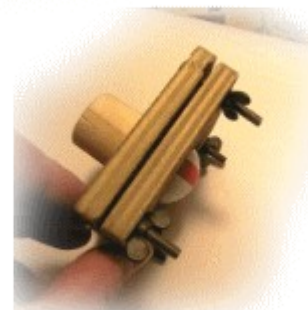
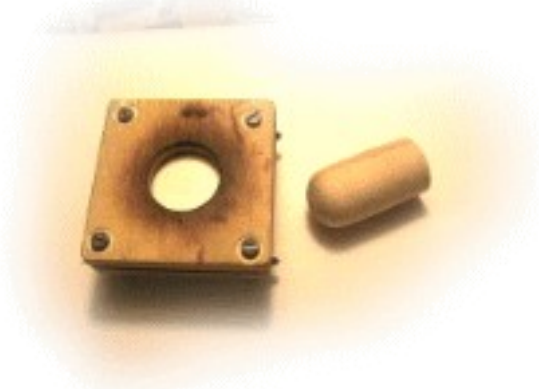
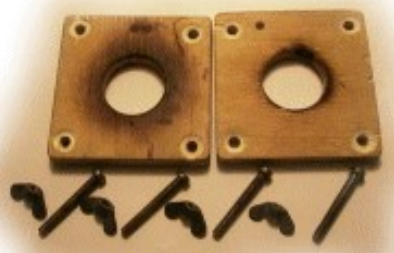
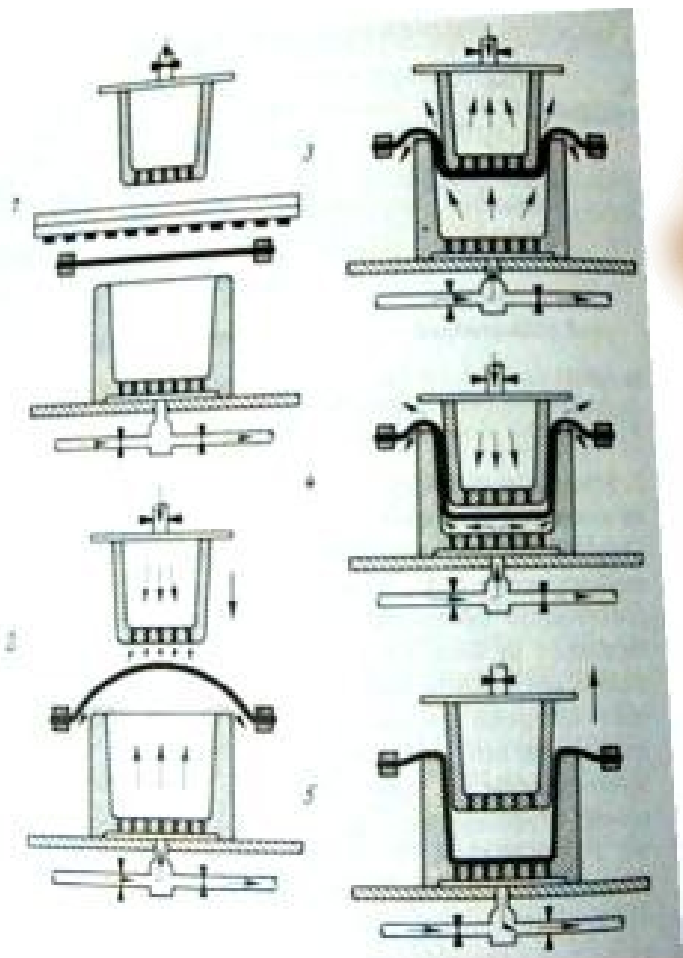

Pred vlečenjem

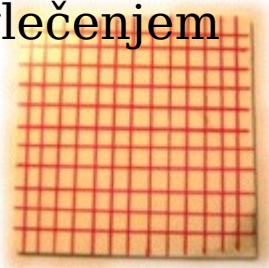

Po vlečenju

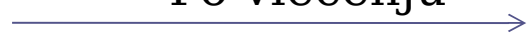
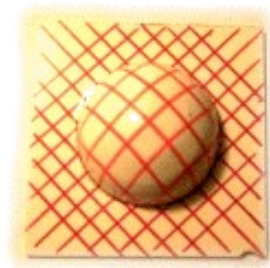

- Litje



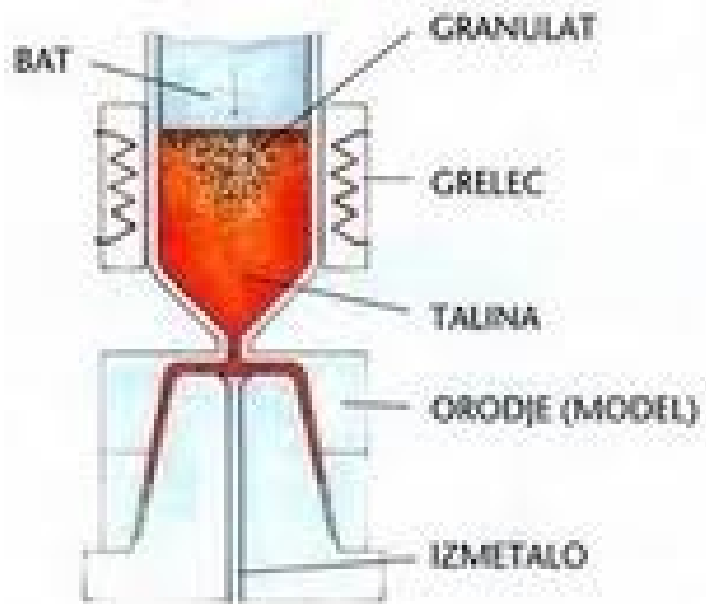

- Vijačenjem
- Kovičenjem
- Lepljenjem
- Varjenjem



## VAKUUMSKO OBLIKOVANJE

<http://www.youtube.com/watch?v=kLxTTHPRwOo>

## OBLIKOVANJE S KALUPI

<http://www.youtube.com/watch?v=nuSyohctiUE>

# VIRI

- YouTube
- Učbenik za tehniko in tehnologijo za 7. razred
- Wikipedija
- Google slike
- Spletna stran : index.htm

[http://www2.arnes.si/~kkovac6/MATERIA LI/ro.zrsss.si/\\_puncer/mase/index.htm](http://www2.arnes.si/~kkovac6/MATERIA LI/ro.zrsss.si/_puncer/mase/index.htm)