

# PATENT



moj **Mikro**

# Kaj je Patent ?



Patent je izključna pravica fizične ali pravne osebe za izum, ki je nov, na inventivni ravni in je industrijsko uporabljiv.

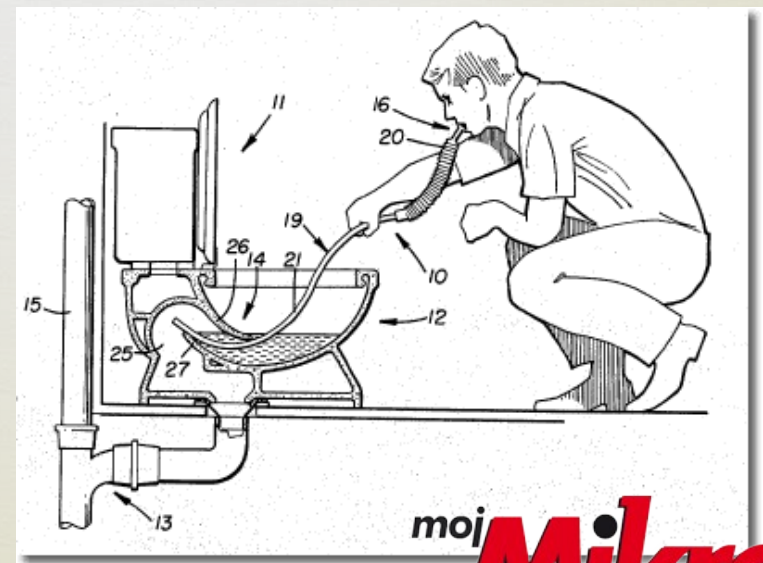

moj **Mikro**

# Nori Patenti

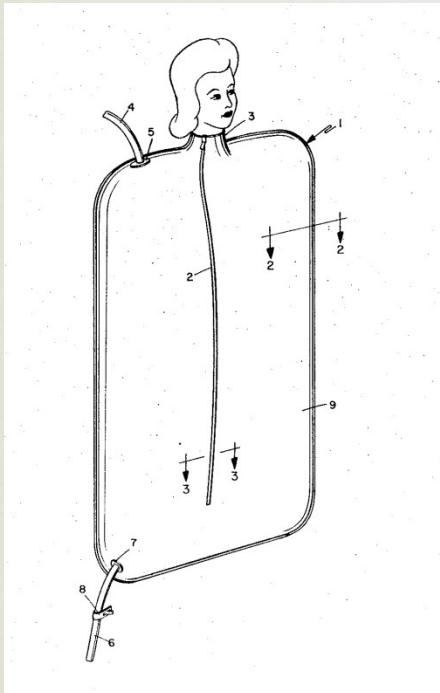

**United States Patent** [19]  
**Barmby**

[11] **4,344,424**

[45] **Aug. 17, 1982**

[54] **ANTI-EATING FACE MASK**

[76] **Inventor:** Lucy L. Barmby, 9550 Jackson Rd., Sacramento, Calif. 95826

[21] **Appl. No.:** 134,557

[22] **Filed:** Mar. 27, 1980

[51] **Int. Cl.<sup>3</sup>** ..... A61F 5/56

[52] **U.S. Cl.** ..... 128/136

[58] **Field of Search** ..... 128/133, 136, 137

[56] **References Cited**

**U.S. PATENT DOCUMENTS**

853,025	5/1907	McCalmont	128/133
1,297,842	3/1919	Harlee	128/136
1,629,892	5/1927	Storms	128/136
2,276,612	3/1942	Ellis	128/136

3,189,073	6/1965	Todd	128/133
3,818,906	6/1974	Stubbs	128/136

*Primary Examiner*—Kyle L. Howell  
*Assistant Examiner*—C. W. Shedd  
*Attorney, Agent, or Firm*—Blair, Brown & Kreten

[57] **ABSTRACT**

An anti-eating face mask which includes a cup-shaped member conforming to the shape of the mouth and chin area of the user, together with a hoop member and straps detachably engageable with a user's head for mounting the cup-shaped member in overlying relationship with the user's mouth and chin area under the nose thereby preventing the ingestion of food by the user.

**2 Claims, 3 Drawing Figures**

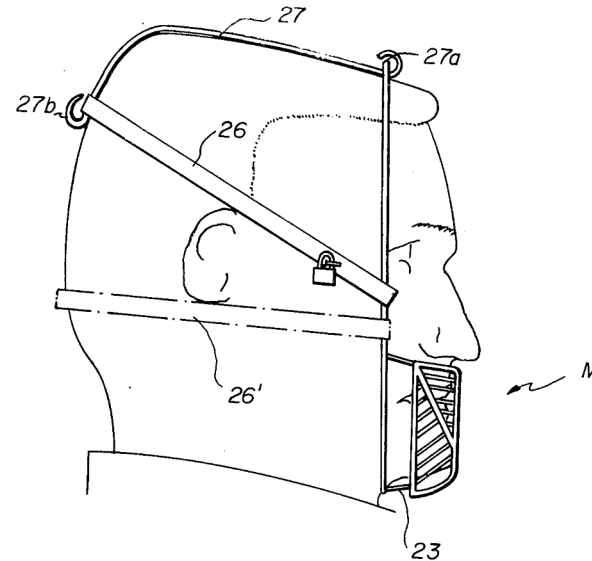

# Zgodovina Patenta



Zgodovina patentov in patentnih zakonov se je začela v Italiji v Beneškem statutu leta 1474.

Izdali so odlok, s katerim nove in invetivne naprave, potem ko so bile v rabi je treba sporočiti republiki, da pridobi pravice pred potencialnimi kršitelji. Obdobje varstva je bilo 10 let.

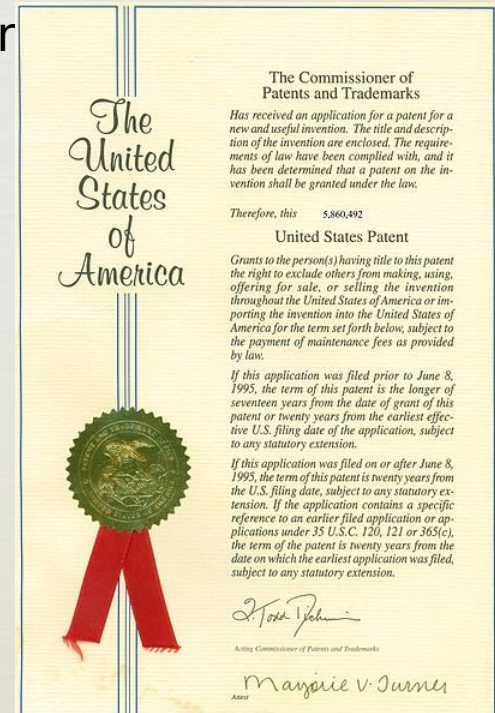

# Česa ne moremo patentirati ?

---

Patentirati ne moremo :

- Odkritij
- Znanstvenih teorij
- Matematičnih metode
- Načrtov
- Patentirati ne moremo tudi za izume kirurškega ali diagnostičnega postopka ali postopka zdravljenja.

# Kakšne Pravice daje Patent ?



Patent daje imetniku izključno pravico preprečiti tretjim, da bi brez njegovega soglasja uporabljali, ponujali, prodajali ali uvažali.

V primeru, da se to krši imetnik patenta uveljavi pravico s tožbo na pristojnem sodišču.

# Pot in pogoji za pridobitev patenta

---



Pogoji za podelitev patenta so naslednji:

- izum je nov in nikjer na svetu nesme obstajati dokazilo, da je že patentiran.
- izum mora biti inventiven
- izum mora biti industrijsko uporabljiv.

# Pot in pogoji za pridobitev patenta

---



Patente podeljujejo državni organi, ki jih država pooblasti.

Če želimo patentirati, moramo vložiti zahtevo za podelitev patenta na Urad RS za Intelektualno lastnino. Istočasno je potrebno vložiti :

- Opis izuma, patentne zahtevke, izvleček in skice, če so potrebne.

Pristojbina v Sloveniji je 110 evrov.



# Pridobitev patenta v drugih državah

---



Če želimo pridobiti patent v večjem številu držav, pa imamo na voljo več poti.

- V vsaki posamezni državi
- Mednarodni organizaciji

## Zanimivost

---



Thomas Edison je patentiral, kar 1,093 patentov vključno z žarnico, električne železnice, kamero za snemanje, baterije...

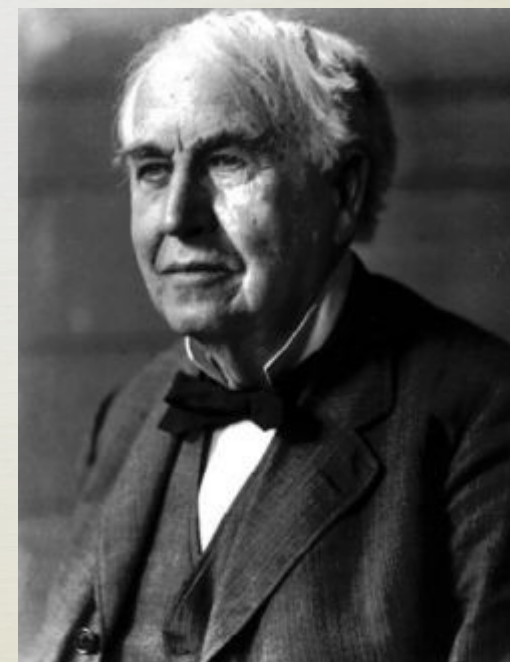
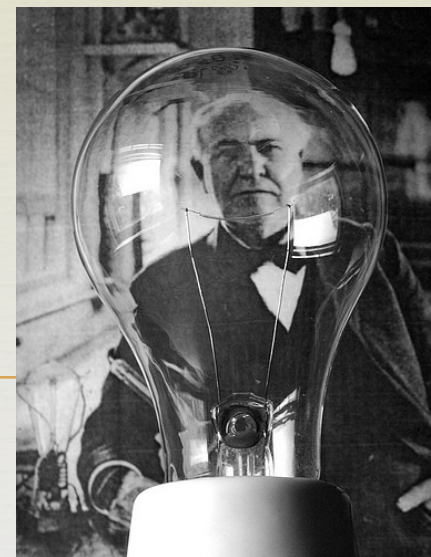

# Patenti zavirajo inovacije

## „Patente vojne“

Smisel patentov je :

- Varovanje intelektualne lastnine.

Golo število patenov onemogoča vstop **malih inovativih** podjetij, da bi plačevala intelektualne pravice in se branila na sodiščih.

Podjetja imajo v lasti več kot **250 tisoč patentov**.  
(točno število ni znano)



# Patent



## Mobile Communications Related Issued Patents (USPTO and EPO) 1993-2011

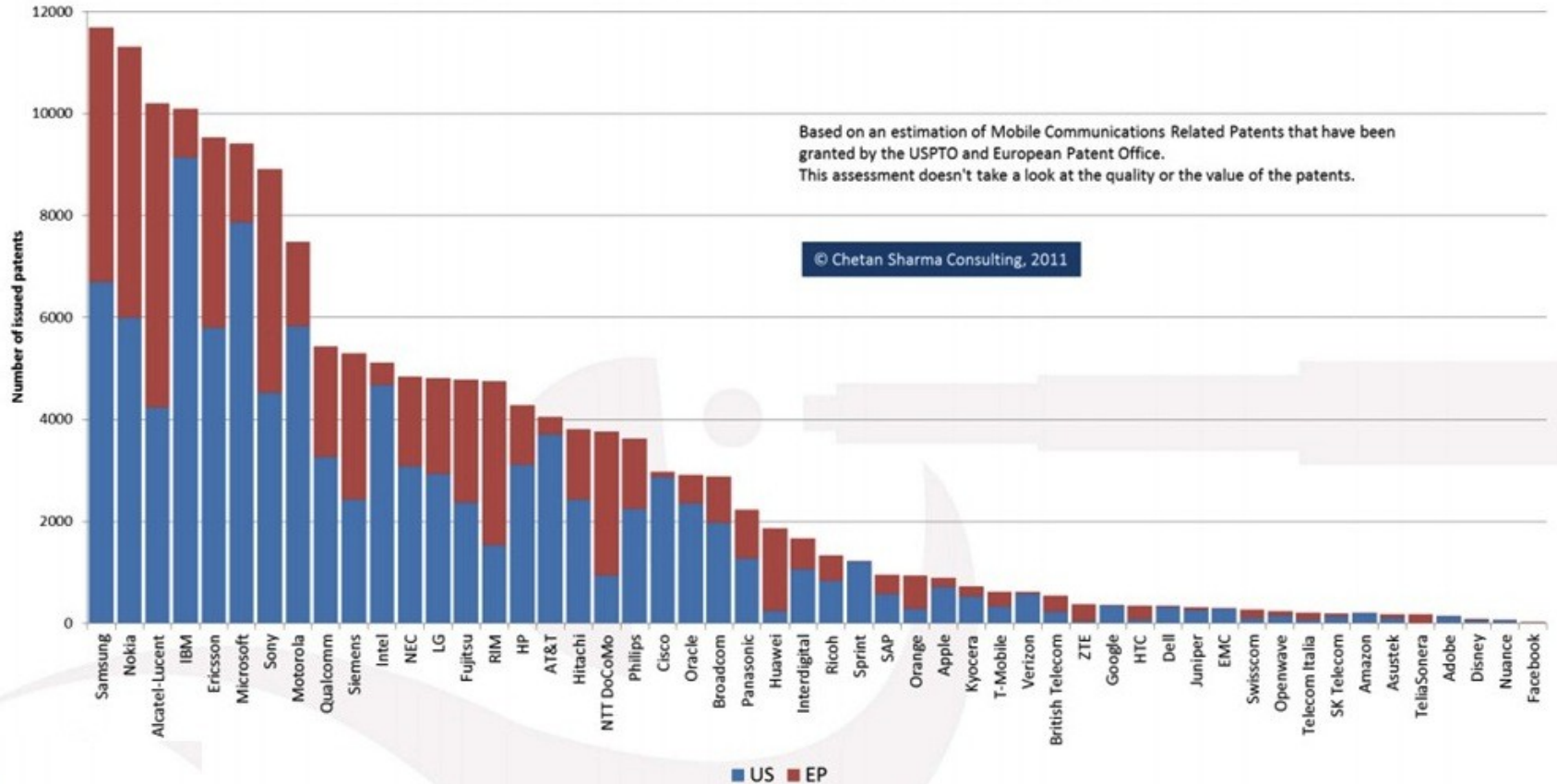

# Registracija patentov glede po državah

Rank	Country	No. of Patents
1	 <a href="#">United States</a>	197,019
2	 <a href="#">Japan</a>	185,827
3	 <a href="#">South Korea</a>	63,865
4	 <a href="#">Germany</a>	48,700
5	 <a href="#">France</a>	22,413
6	 <a href="#">China</a>	21,519
7	 <a href="#">Russia</a>	19,948
8	 <a href="#">United Kingdom</a>	13,304
9	 <a href="#">Switzerland</a>	8,583
10	 <a href="#">Netherlands</a>	8,416

# Viri



moj **Mikro**

Moj Mikro :

[http://www.mojmikro.si/center/povem\\_naglas/patenti\\_zavirajo\\_inovacije](http://www.mojmikro.si/center/povem_naglas/patenti_zavirajo_inovacije)

<http://www.funnypatent.com/weird.html>

<http://www.zascitite.si/patenti.php>

<http://www.pretnar-consulting.com/faq.html>